

# *TECHNICAL INFORMATION*

---

## **CITIZEN QUARTZ**

**Cal. No. C100**

**Cal. No. C110**



[Cal. No. C100]



[Cal. No. C110]

## CONTENTS

<b>1</b>	<b>OUTLINE</b> .....	1
<b>2</b>	<b>SPECIFICATIONS</b> .....	2
<b>3</b>	<b>OPERATING METHOD</b>	
	<b>3-1</b> OPERATING METHOD CAL C100 .....	4
	<b>3-2</b> OPERATING METHOD CAL C110 .....	17
<b>4</b>	<b>PRECAUTIONS FOR REPLACING THE POWER CELL</b> .....	24
<b>5</b>	<b>DISASSEMBLE AND ASSEMBLE OF MODULE</b> .....	25
<b>6</b>	<b>INSPECTION AND ADJUSTMENT METHOD OF MODULE</b> .....	28

## 1 OUTLINE

### • CAL C100

This is a combination watch intending for pilots, which is capable of indicating the time in three different time zones. Furthermore, it is capable of conducting many different kinds of calculation with the register ring.

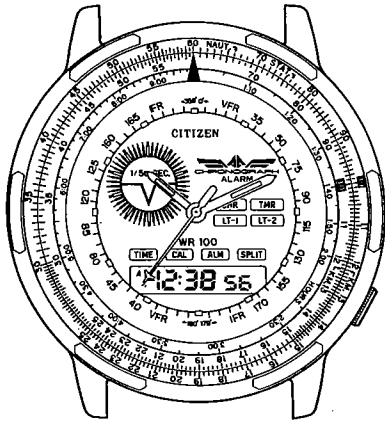

- Time mode
- Calendar mode
- Alarm mode
- Chronograph mode
- Timer mode
- Local time 1 mode
- Local time 2 mode

### • CAL C110

This is a combination watch equipped with the unique graphic display mechanism and various kinds of function.



- Time mode
- Calendar mode
- Alarm mode
- Chronograph mode
- Timer mode

## 2 SPECIFICATIONS

Caliber No.	C100	
Type	Combination watch	
Module size (mm)	26.0 x 27.4 Thickness: 4.9	
Accuracy (at normal temperature)	±20 sec./month (5°C ~ 30°C)	
Oscillation	32,768 Hz	
Display method	FE nematic LC (Liquid Crystal)	
Integrated circuit	C/MOS-LSI (1 unit)	
Effective temperature range	0°C to +55°C (32°F to 131°F)	
Adjustment of time rate	Trimmer condenser	
Measurement of time rate	2 seconds	
Display function	Time	(AM/PM) Hour, minute, second Time difference correcting function.
	Calendar	Month, date, day (Year is indicated under the correction state.) (1991 through 2006)
	Alarm	(AM/PM) Hour, minute, ON/OFF 12/24 hour systems are in accordance with the time mode.
	Chronograph	Less than 60 minutes: 24 hours watch Minute, second, 1/100 second. 60 minutes or more: Hour, minute, second Setting range is 60 minutes to 1 minute.
	Timer	(Initial state) Minute (Running state) Minute, second Setting range is 60 minutes to 1 minute.
	Local time 1	(AM/PM) Hour, minute, 12/24 hour systems are in accordance with the time mode.
	Local time 2	(AM/PM) Hour, minute, 12/24 hour systems are in accordance with the time mode.
Battery	Part No.	280-44
	Battery code	SR927W
	Nominal voltage	1.55 V
	Nominal capacity	55 mA <sub>H</sub>
	Lifetime	Approx. 2 years
Current consumption	within 3.1 μA	
Coil resistance	2.2 kΩ ~ 2.6 kΩ	

Caliber No.	C110	
Type	Combination watch	
Module size (mm)	26.0 x 27.4 Thickness: 4.9	
Accuracy (at normal temperature)	±20 sec./month (5°C ~ 30°C)	
Oscillation	32,768 Hz	
Display method	FE nematic LC (Liquid Crystal)	
Integrated circuit	C/MOS-LSI (1 unit)	
Effective temperature range	0°C to +55°C (32°F to 131°F)	
Adjustment of time rate	Trimmer condenser	
Measurement of time rate	2 seconds	
Display function	Time	(AM/PM) Hour, minute, second.
	Calendar	Month, date, day (Year is indicated under the correction state.) (1991 through 2006)
	Alarm	(AM/PM) Hour, minute, ON/OFF 12/24 hour systems are in accordance with the time mode.
	Chronograph	Less than 60 minutes: 24 hours watch Minute, second, 1/100 second. 60 minutes or more: Hour, minute, second Split-time measuring function.
	Timer	(Initial state) Minute (Running state) Minute, second. Setting range is 60 minutes to 1 minute.
Battery	Part No.	280-44
	Battery code	SR927W
	Nominal voltage	1.55 V
	Nominal capacity	55 mAH
	Lifetime	Approx. 2 years
Current consumption	within 3.1 µA	
Coil resistance	2.2 kΩ ~ 2.6 kΩ	

### 3-1 OPERATION METHOD CAL C100

#### §1 NAME OF EACH PART

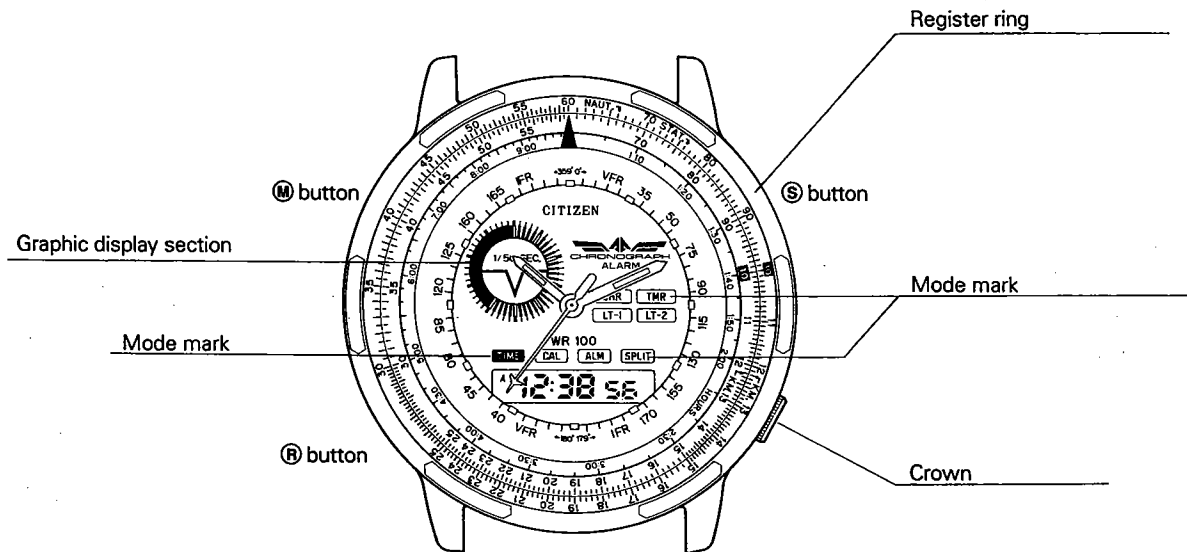

#### §2 HOW TO SET ANALOG SECTION (Common to CAL C100 and C110)

- Set the time with the crown pulled out to the first click.
- Set the digital section and analog section independently from each other.

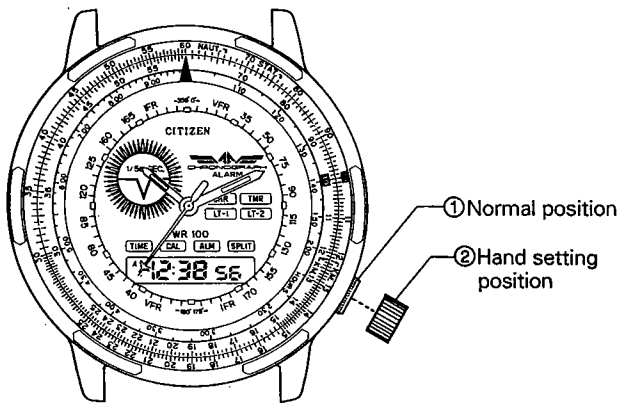

<Cal. No. C100>

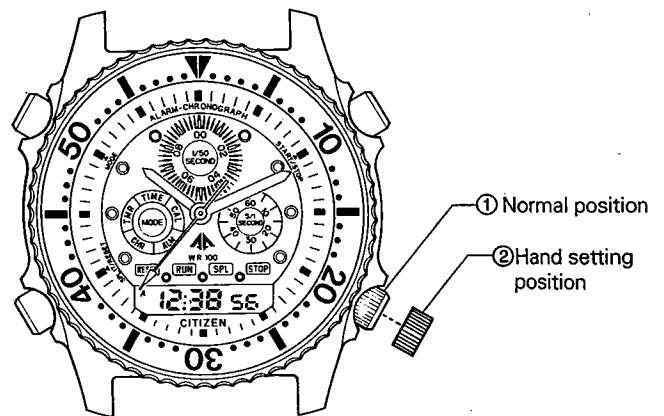

<Cal. No. C110>

### 53 OUTLINE OF DIGITAL DISPLAY SECTION

This combination watch can be operated under the seven different operation modes, the time mode, calendar mode, alarm mode, chronograph mode, timer mode and local time 1 and 2 modes. The operation mode is changed in the following order every time the (M) button is pressed.

\* The mode mark indicates the current mode.

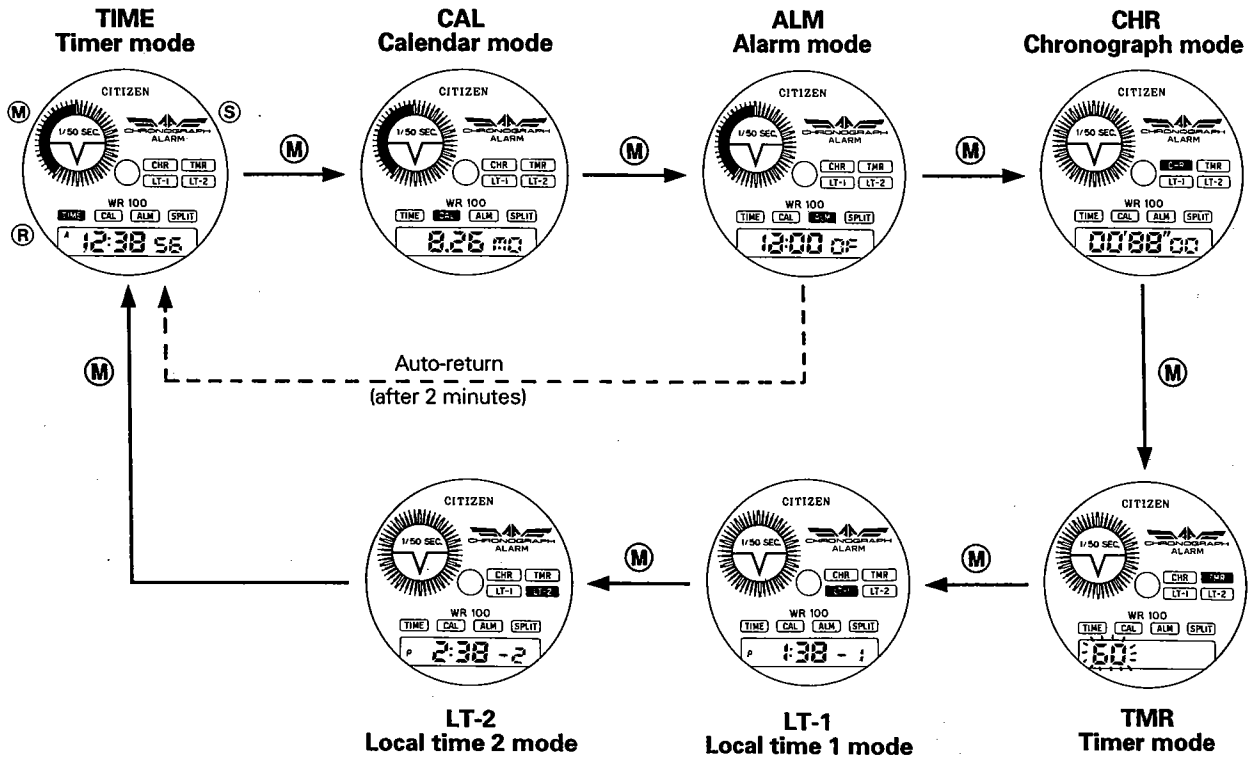

- **Auto return**

If the watch is left untouched for about two minutes in the alarm mode, the watch is automatically brought to the time mode.

- **Manual return**

If the (M) button is kept pressed for about two seconds, the watch is forcibly returned to the time mode after calling up any mode other than the current mode.

## §4 OPERATING METHOD UNDER EACH OPERATION MODE

### a. TIMER MODE (TIME)

Time is indicated on the watch under this mode. Furthermore, time difference correcting function is available under this mode. A graphic display is simultaneously given corresponding to the time shown.

#### Setting method of time

- Under the time mode, keep pressing the **(S)** button for about two seconds to set the watch in the state under which second can be corrected. Then correct the second properly with the **(R)** button. Then, call the digit to be corrected by pressing the **(S)** button, and correct it with the **(R)** button.
- If the **(R)** button is kept pressed when the watch is in the correction state, the indicated digit is changed quickly.  
(except setting of second and change of 12/24 hour systems).

#### Operating method of time difference correction

- If the **(R)** button is kept pressed for 2 seconds or longer, the watch is set to the time difference correction mode. Then the time difference can be corrected in increments of 1 hour by pressing the **(R)** button.  
If the **(S)** button is pressed in the hour correction mode, the mode changes to the minute correction mode. Now, the time difference is corrected in increments of 30 minutes by pressing the **(R)** button.

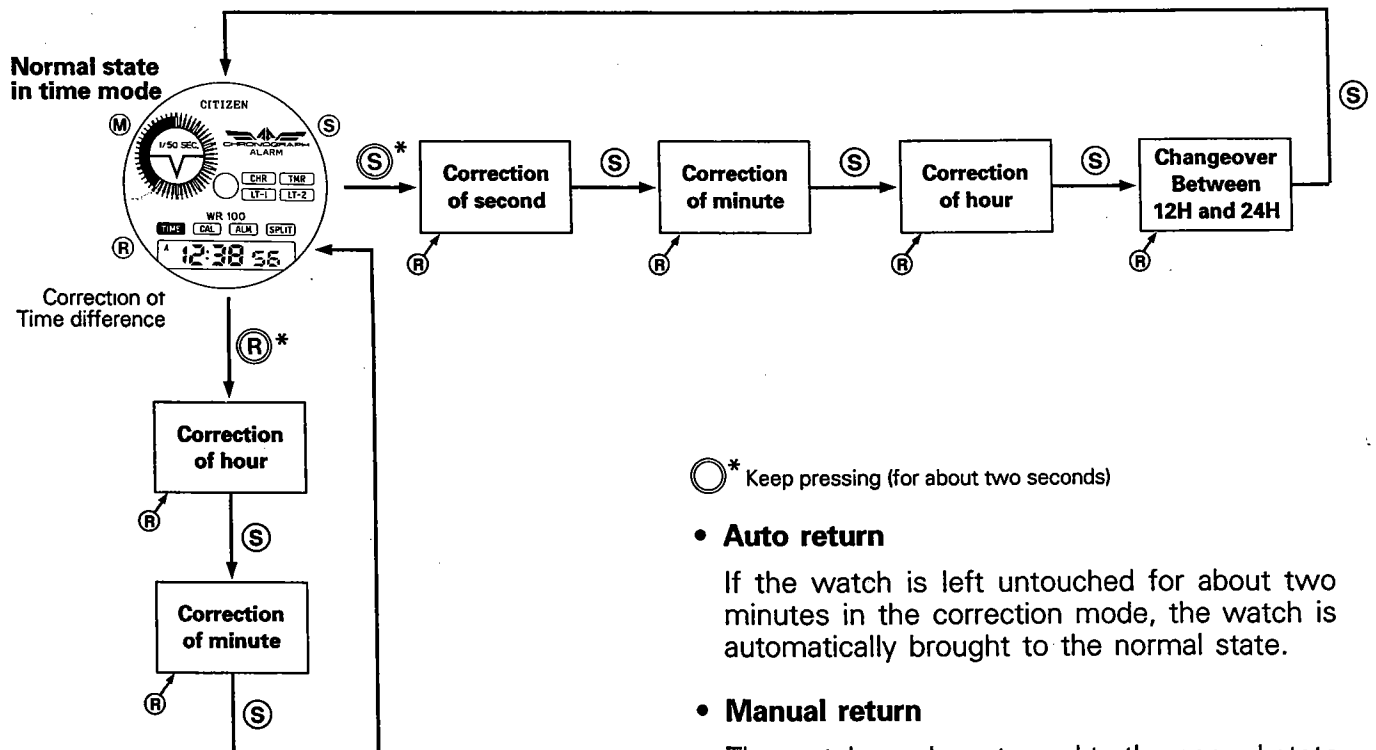



- If the second is set during the period of 30 to 59 seconds, the minute goes forward by one minute.

 **(Other notes in setting time)**

- When the time is corrected to adjust the normal time with accuracy, the time in the local time 1 and 2 modes will also be corrected automatically in accordance with the normal time adjustment. (Local time linkage feature)

**Example**

Normal time	9 (H) 58 (M) AM	----->	11 (H) 33 (M) 00 (S) AM
Local time 1	7 (H) 58 (M) AM or PM	----->	9 (H) 32 (M) AM or PM
Local time 2	11 (H) 28 (M) PM	----->	1 (H) 02 (M) AM

Note that the time in the local time 1 and 2 modes will not change if adjusting the normal time after performing the time difference correcting procedure.

**b. CALENDAR MODE (CAL)**

Under the normal state in the calendar mode, month, date and day of the week are indicated on the watch.

**Setting the calendar**

- Under the calendar mode, keep pressing the **(S)** button for about two seconds to set the watch in the state under which month can be corrected. Then correct the month properly with the **(R)** button. Then, call the item to be corrected by pressing the **(S)** button, and correct it with the **(R)** button.
- If the **(R)** button is kept pressed when the watch is in the correction state, the indicated item is changed quickly.

**• Auto return**

If the watch is left untouched for about two minutes in the correction mode, the watch is automatically brought to the normal state.

**• Manual return**

The watch can be returned to the normal state in the calendar mode from any correction state by pressing the **(M)** button.

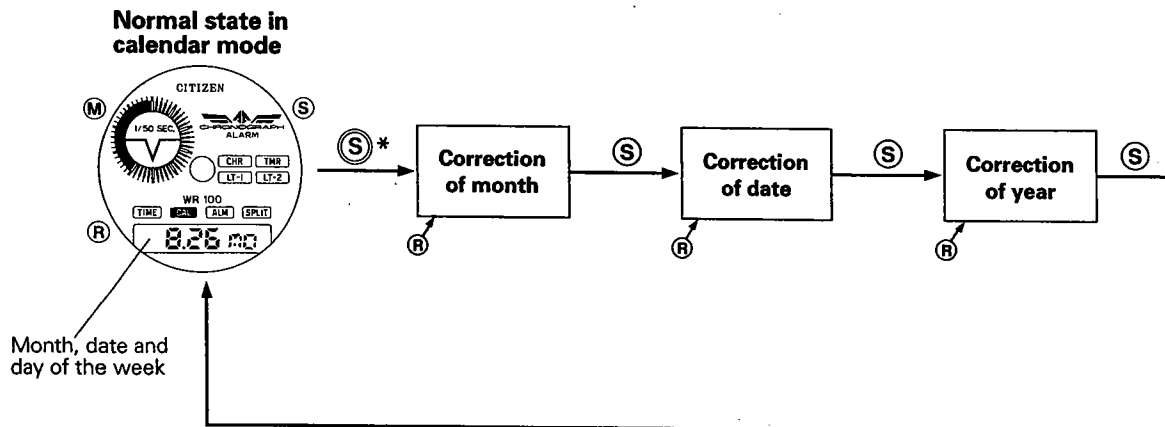

**(S)\*** Keep pressing (for about two seconds)

- If a nonexisting date is set, the watch automatically indicates the first of the next month when it is returned to the normal state. **Example:** Feb. 31 → Mar. 01
- The year can be set to 1991 to 2006, and the lower two figures are indicated in the correction state.
- The day of the week is automatically set when the year, month and date are set.
- No correction of the end of the month of calendar is required as far as the years of 1991 through 2006 are concerned.

**c. ALARM MODE (ALM)**

**Setting method of alarm**

- The alarm is turned on and off every time the (R) button is pressed in the alarm mode. (At this time, a confirmation sound comes out.)
- Under the alarm mode, keep pressing the (S) button for about two seconds to set the watch in the state under which alarm can be corrected. Then correct the time of alarm properly with the (R) button. Then, call the digit to be corrected by pressing the (S) button, and correct it with the (R) button.
- If the (R) button is kept pressed when the watch is in the correction state, the indicated digit is changed quickly.
- The 12/24H systems are in accordance with the time mode.
- The alarm sounds for about 20 seconds. It can be stopped by pressing any button.
- The alarm does not sound in the correction state under any operation mode.

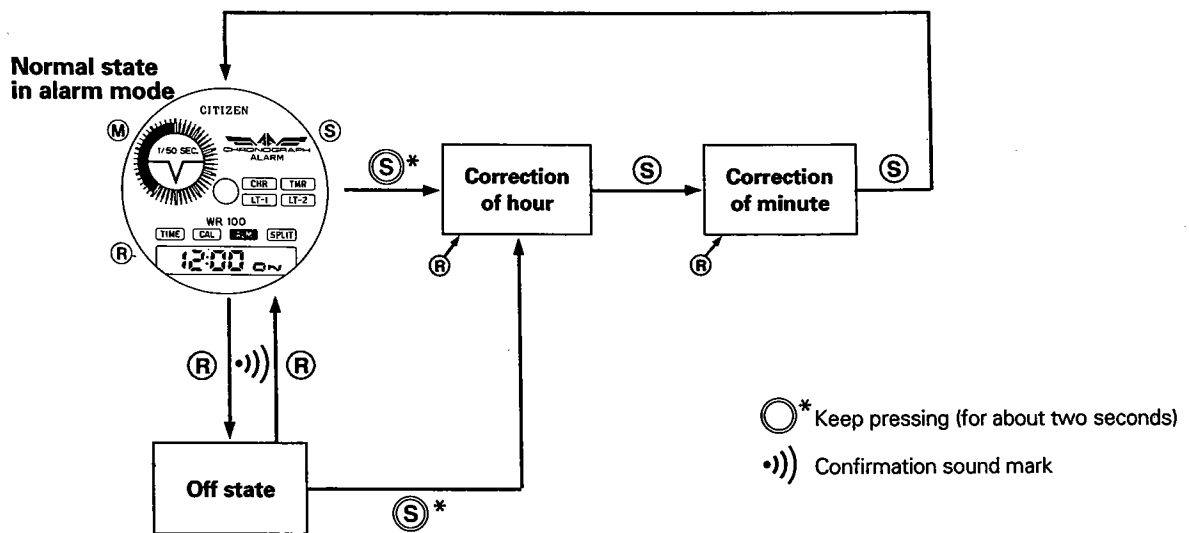

**• Auto return**

If the watch is left untouched for about two minutes in the correction mode, the watch is automatically brought to the normal state.

**• Manual return**

The watch can be returned to the normal state in the alarm mode from any correction state by pressing the (M) button.

**• Alarm monitor**

If the (R) button is pushed and held, the alarm sounds for monitoring.

#### d. CHRONOGRAPH MODE (CHR)

##### Operating method of chronograph

- Under the chronograph mode, the watch is started/stopped by pressing the **(S)** button.  
If pressing the **(R)** button while the chronograph is running, the chronograph is brought to the split operation mode and split time is indicated for about 10 seconds. If pressing the **(R)** button in the split time indication state, the split time is added by the period of time passed after the split operation mode started.

##### <Measuring range>

Zero (0) hour 00 minute 00 second to 23 hours 59 minutes 59 seconds 99/100 seconds  
After 24 hours 00 minute 00 second have passed, the indication will be reset.

- If the **(R)** button is pressed in the stop state, the chronograph will be reset.
- Under the chronograph mode, the mode can be changed by pressing the **(M)** button in any state.  
While the chronograph is running, it does not stop even if changing the mode.

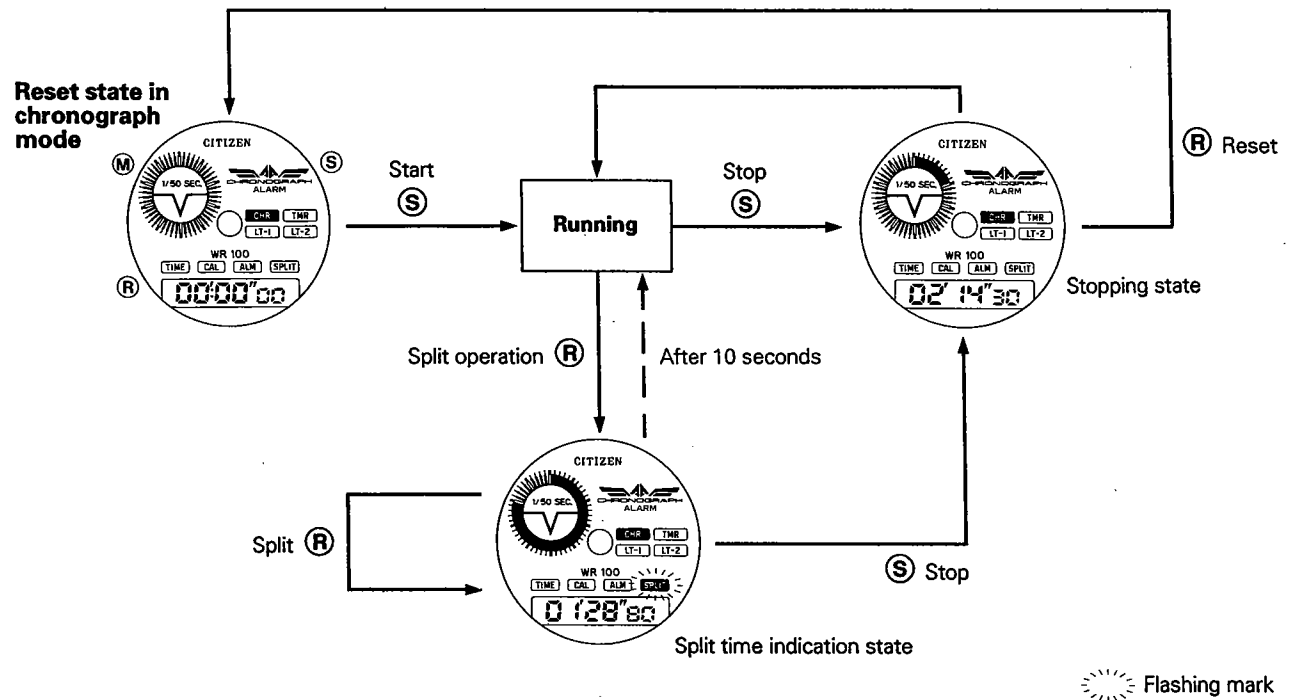

**e. TIMER MODE (TMR)**

Graphic indication is given in accordance with the timer indication.

**Handling method of timer**

• **Setting the timer**

In the initial setting state, the timer can be set by pressing the (R) button. If the (R) button is kept pressed, the indicated item can be corrected quickly.

The timer can be set to 1 minutes through 60 minutes by steps of 1 minute.

• **Start operation**

If the (S) button is pressed in the initial setting state, the timer starts counting down from its initial setting state.

• **Fly-back operation**

If the (R) button is pressed while the timer is running, the timer returns to the initial setting state in the fly-back operation mode and re-starts counting down from the initial setting state.

• **Stop operation**

If the (S) button is pressed while the timer is running, the timer stops running in its stop state. If the (S) button is pressed in this starts again.

• **Time-up sound**

The alarm sounds for about five seconds each time the timer is up, and the timer returns to the initial setting state.

• **Reset**

If the (R) button is pressed in the stop state, the timer is reset to the initial setting state.

- Under the timer mode, the mode can be changed by pressing the (M) button in any state. While the timer is running, the timer keeps running even if changing the mode.

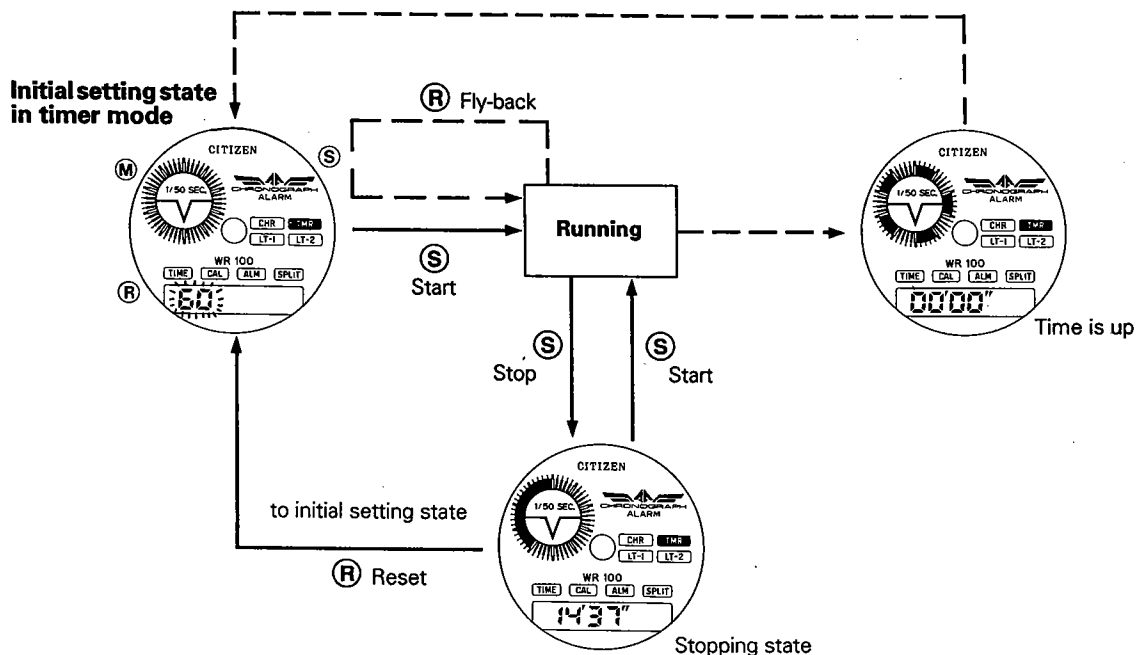

**f. LOCAL TIME 1 MODE, LOCAL TIME 2 MODE (LT-1 and -2)**

These modes are very helpful, which always tell the time to always know the time in the different time zones.

**Setting method of the local time (common to the LT-1 and -2)**

- Under the local time mode, keep pressing the **(S)** button for about two seconds to set the watch in the state under which the hour of local time can be corrected. Then correct the hour properly with the **(R)** button. If pressing the **(S)** button again, the mode changes to the minute correction mode under which the minute can be corrected with the **(R)** button in increments of 30 minutes.

**• Note**

When the normal time is corrected under the time mode, the time in the local time 1 and 2 modes will also be corrected automatically in accordance with the normal time adjustment. Refer to the description in the time mode for details.

**• Auto return**

If the watch is left untouched for about two minutes in the correction mode, the watch is automatically brought to the normal state.

**• Manual return**

The watch can be returned to the normal state in the alarm mode from any correction state by pressing the **(M)** button.

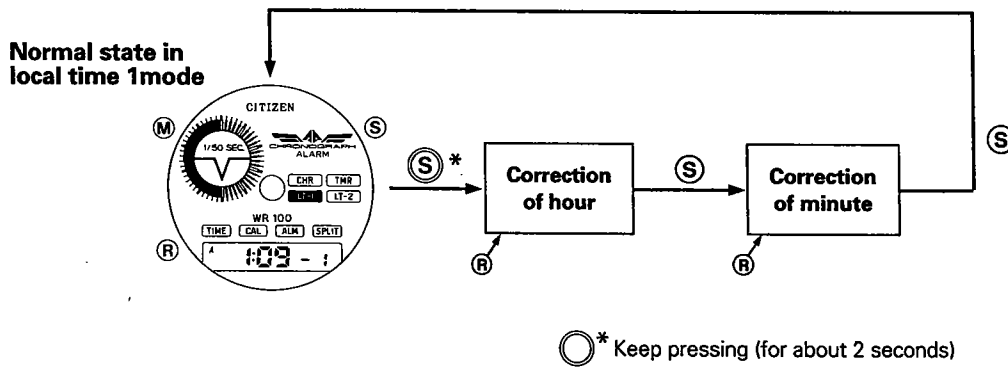

## §5 HANDLING METHOD OF REGISTER RING

<Name of scale and marks>

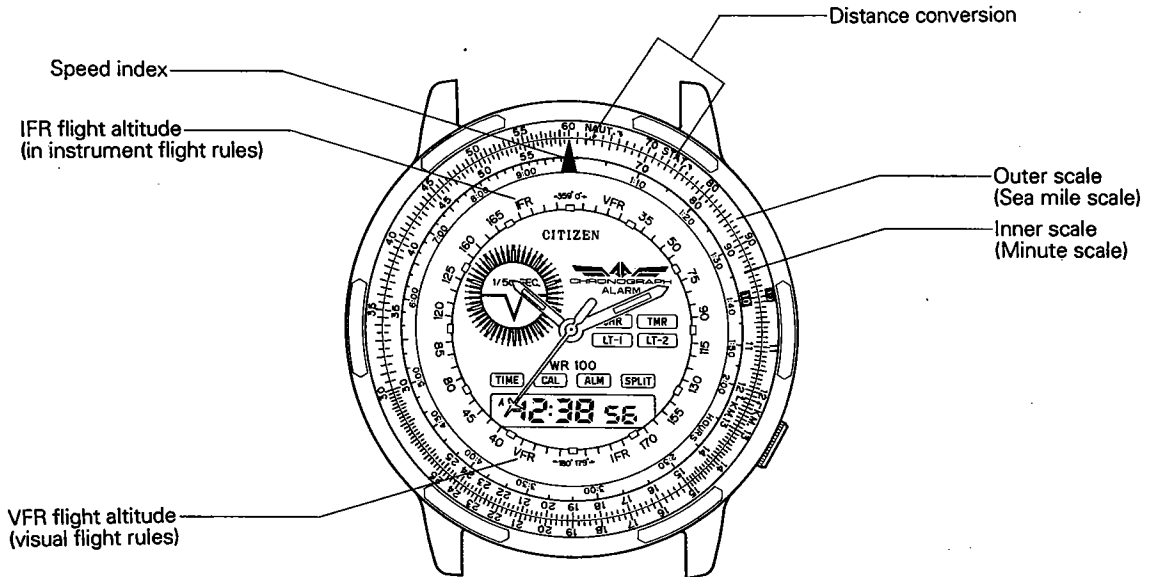

### CALCULATING FUNCTION

When using the calculating function of this watch, observe the following.

- Use the results of the calculation by this watch for reference only.
- The user cannot determine the position of the unit with the scale of this watch.

#### Function of calculating the navigation

##### 1) Calculation of required time

(Example)

How long does it take to fly 450 sea miles at the speed of 180 Kt?

(Answer)

Set the 18 point of the outer scale to the SPEED INDEX (▲) of the inner scale, and the point of the inner scale (2:30) correspond to the 45 of the outer scale is the time required (2 hours and 30 minutes).

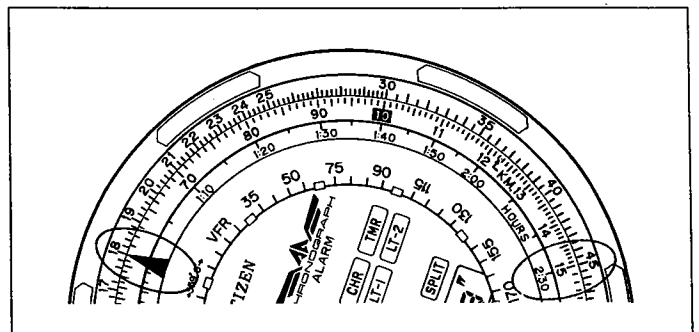

2) Calculation of speed (absolute speed)

(Example)

What is the speed when the flight distance is 240 sea miles and the flight time is one hour and 20 minutes?

(Answer)

Set the 24 point of the outer scale to the 1:20 (80) of the inner scale, and the 18 (180 Kt) corresponding to the SPEED INDEX (▲) of the inner scale is obtained.

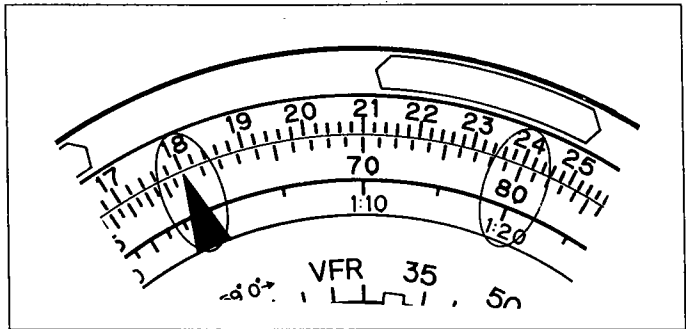

3) Calculation of flight distance

(Example)

What is the flight distance when the speed is 240 Kt and the flight time is 40 minutes?

(Answer)

Set the 21 point of the outer scale to the SPEED INDEX (▲) of the inner scale, and the 14 (140 sea miles) corresponding to the 40 point of the inner scale is obtained.

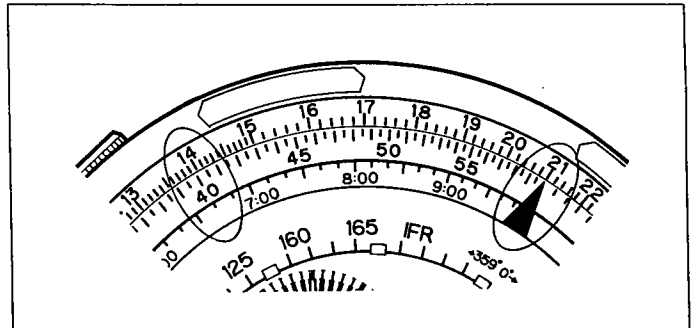

4) Calculation of fuel consumption ratio

(Example)

How is the fuel consumption ratio when the flight time is 30 minutes and 120 gallons of the fuel is consumed?

(Answer)

Set the 12 point of the outer scale to the 30 point of the inner scale, and the 24 (42 gallons/hour) point corresponding to the SPEED INDEX (▲) is obtained.

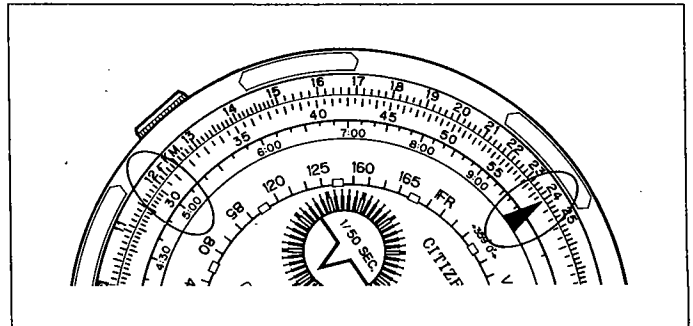

5) Calculation of quantity of consumed fuel

(Example)

How much fuel is consumed when the fuel consumption ratio is 250 gallons/h and the flight time is 6 hours?

(Answer)

Set the 25 point of the outer scale to the SPEED INDEX (▲) of the inner scale, and the 15 (1500 gallons) corresponding to 6:00 is obtained.

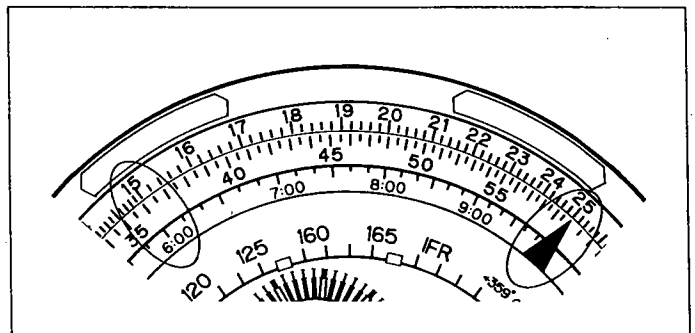

- 6) Calculation of how long the airplane can fly

(Example)

How long the airplane can fly when the fuel consumption ratio is 220 gallons/h and 550 gallons of the fuel can be consumed?

(Answer)

Set the 22 point of the outer scale to the SPEED INDEX (▲) of the inner scale, and the 2:30 point (2 hours and 30 minutes) corresponding to the 55 point of the outer scale is obtained.

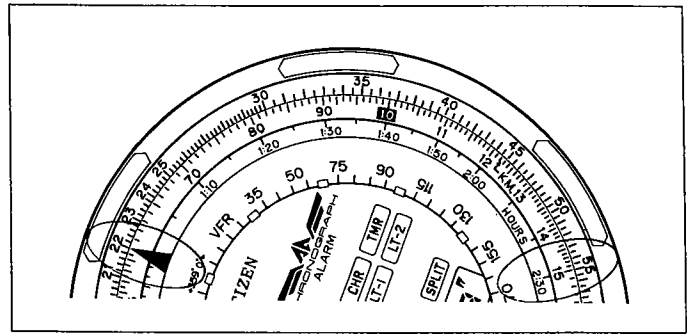

- 7) Calculation of descending altitude

The descending altitude is calculated using the descending ratio and the period of time required for descending

(Example)

What is the descending altitude when the descending ratio is 250 feet/minute and the airplane keeps descending for 23 minutes?

(Answer)

Set the 25 of the outer scale to the 10 of the inner scale, and the 57.5 (5750 feet) of the outer scale corresponding to the 23 of the inner scale is obtained.

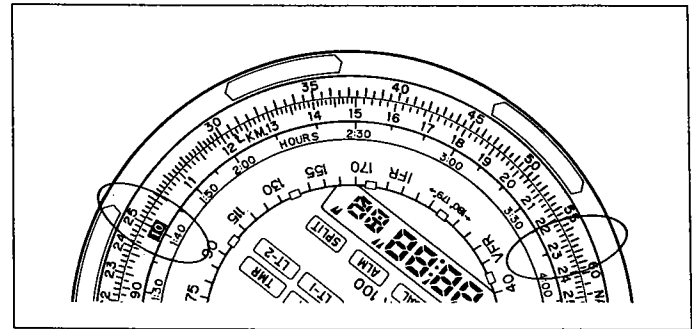

- 8) Calculation of ascending (descending) ratio

The ascending (descending) ratio is calculated using the period of time required to reach a certain altitude.

(Example)

What is the ascending ratio when the airplane keeps ascending for 16 minutes to reach the altitude of 7500 feet?

(Answer)

Set the 75 of the outer scale to the 16 of the inner scale, and the 47 (470 feet) of the outer scale corresponding to the 10 of the inner scale is obtained.

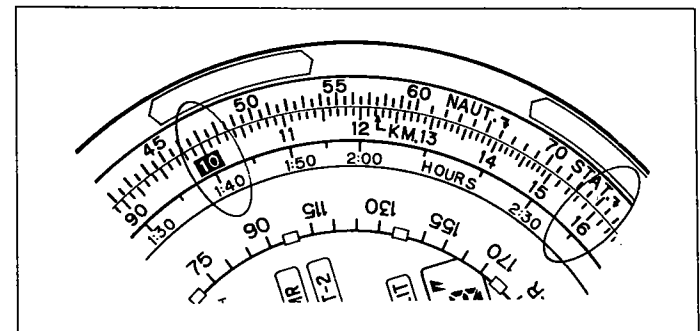



9) Calculation of time required for ascending (descending)

The period of time required to reach the expected altitude is calculated using the altitude and the ascending (descending) ratio

(Example)

How long the air plane take to reach the altitude of 6300 feet when the ascending ratio is 550 feet/minute?

(Answer)

Set the 55 of the outer scale to the 10 of the inner scale, and the 11.5 (11 minutes 30 seconds) of the inner scale corresponding to the 63 of the outer scale is obtained.

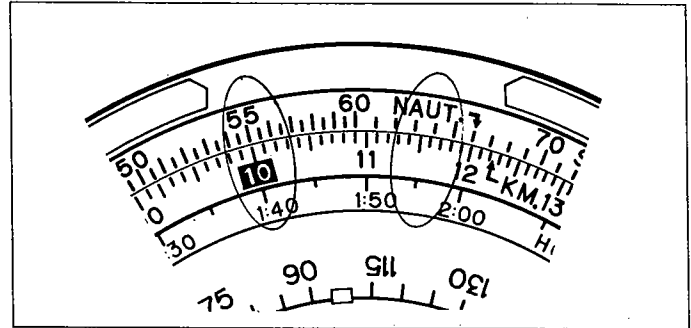

10) Conversion

(Example)

To calculate the sea miles and kilometers corresponding to the 30 miles

(Calculating method)

Set the STAT → of the outer scale to the 30 of the inner scale, and the 26 sea miles corresponding to the NAUT → of the outer scale and the 48.2 kilometers corresponding to the KILOMETER → of the outer scale are obtained.

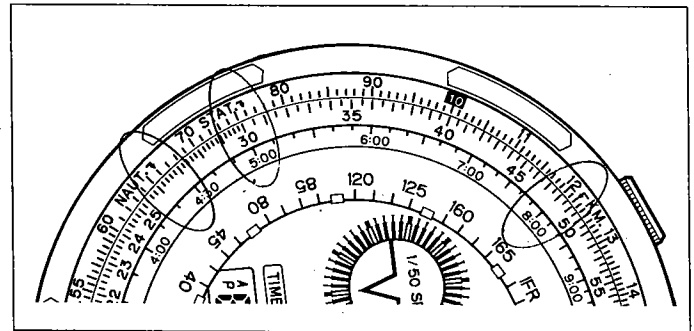

● How to read the flight altitude in VFR (visual flight rules) and IFR (instrument flight rules)

• Flight altitude in VFR (white figures)

When the airplane flies in the direction of 0 – 179, the flight altitude is 1000 feet x Odd number of 500 feet.

When the airplane flies in the direction of 180 – 359, the flight altitude is 1000 feet x Even number of 500 feet.

That is, when the airplane flies from Osaka to Tokyo, its flight altitude is increased to 3500 feet, 5500 feet, 7500 feet, ... in order. When it flies from Osaka to Fukuoka, its flight altitude is increased to 4500 feet, 6500 feet, 8500 feet, ....

• Flight altitude in IFR (Red figures)

When the airplane flies in the direction of 0 – 179, the flight altitude is 1000 feet x Odd number feet.

When the airplane flies in the direction of 180 – 359, the flight altitude is 1000 feet x Even number feet.

The flight altitudes of the airplanes are determined according to their flying methods and directions as shown above to prevent an in-flight collision.

## §6 PRINT ON BAND

The following letters are printed on the bands of some models. These letters are called the "surface-to-air" signal and used as messages to be sent from the ground to air (an airplane etc.) in an emergency.



NEED  
DOCTOR

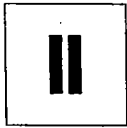

NEED  
MEDICAL  
SUPPLIES



NEED  
FOOD AND  
WATER



YES



NO

### 3-2 OPERATION METHOD CAL C110

#### §1 NAME OF EACH PART

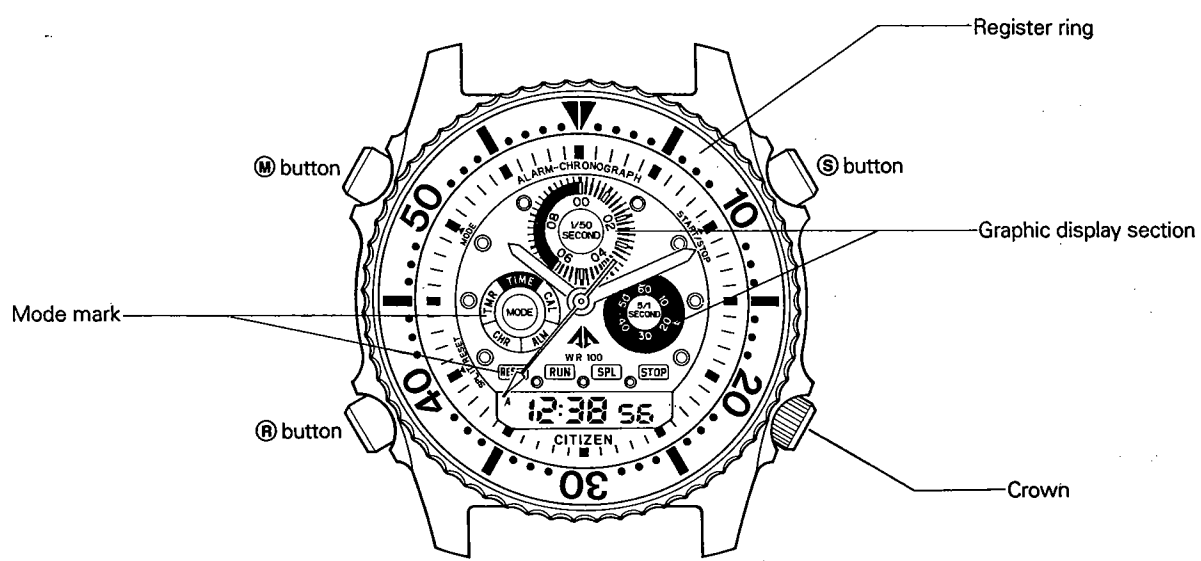

#### §2 OUTLINE OF DIGITAL DISPLAY SECTION

This combination watch can be operated under the five different operation modes, the time mode, calendar mode, alarm mode, chronograph mode and timer mode. The operation mode is changed in the following order every time the **M** button is pressed.

\* The mode mark tells you what is currently indicated on the watch.

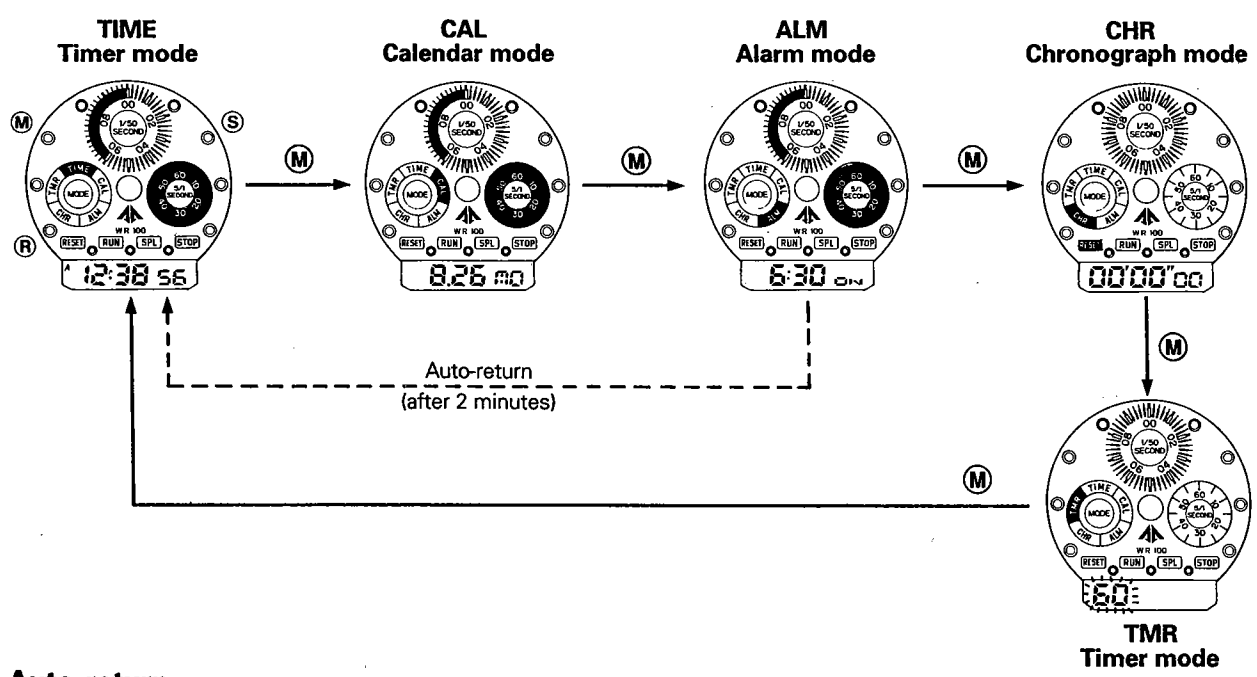

- Auto return**  
 If the watch is left untouched for about two minutes in the alarm mode, the watch is automatically brought to the time mode.
- Manual return**  
 If the **M** button is kept pressed for about two seconds, the watch is forcibly returned to the time mode after calling up any mode other than the current mode.

### §3 OPERATING METHOD UNDER EACH OPERATION MODE

#### a. TIME MODE (TIME)

Time is indicated on the watch and a graphic display is simultaneously given corresponding to the time shown.

#### Setting method of time

- Under the time mode, keep pressing the (S) button for about two seconds to set the watch in the state under which second can be corrected. Then correct the second properly with the (R) button. Then, call the item to be corrected by pressing the (S) button, and correct it with the (R) button.
- If the (R) button is kept pressed when the watch is in the correction state, the indicated item is changed quickly (except setting of second and change of 12/24 hour systems).

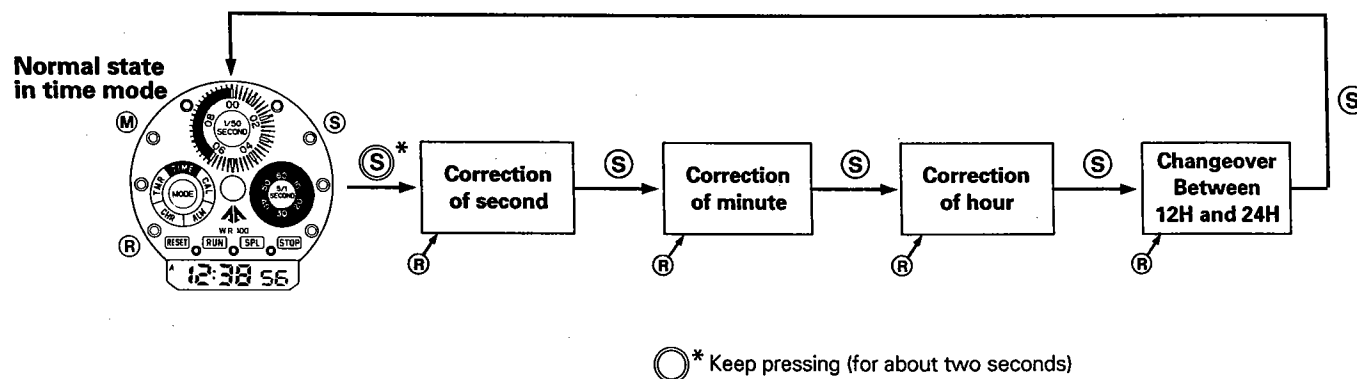

- **Auto return**

If the watch is left untouched for about two minutes in the correction mode, the watch is automatically brought to the normal state.

- **Manual return**

The watch can be returned to the normal state in the time mode from any correction state by pressing the (M) button.

- If the second is set during the period of 30 to 59 seconds, the minute goes forward by one minute. (Under the analog mode, the second is not in accordance with the minute)

## b. CALENDAR MODE (CAL)

Under the normal state in the calendar mode, month, date and day of the week are indicated on the watch.

### Setting the calendar

- Under the calendar mode, keep pressing the **(S)** button for about two seconds to set the watch in the state under which month can be corrected. Then correct the month properly with the **(R)** button. Then, call the item to be corrected by pressing the **(S)** button, and correct it with the **(R)** button.
- If the **(R)** button is kept pressed when the watch is in the correction state, the indicated item is changed quickly.

### • Auto return

If the watch is left untouched for about two minutes in the correction mode, the watch is automatically brought to the normal state.

### • Manual return

The watch can be returned to the normal state in the calendar mode from any correction state by pressing the **(M)** button.

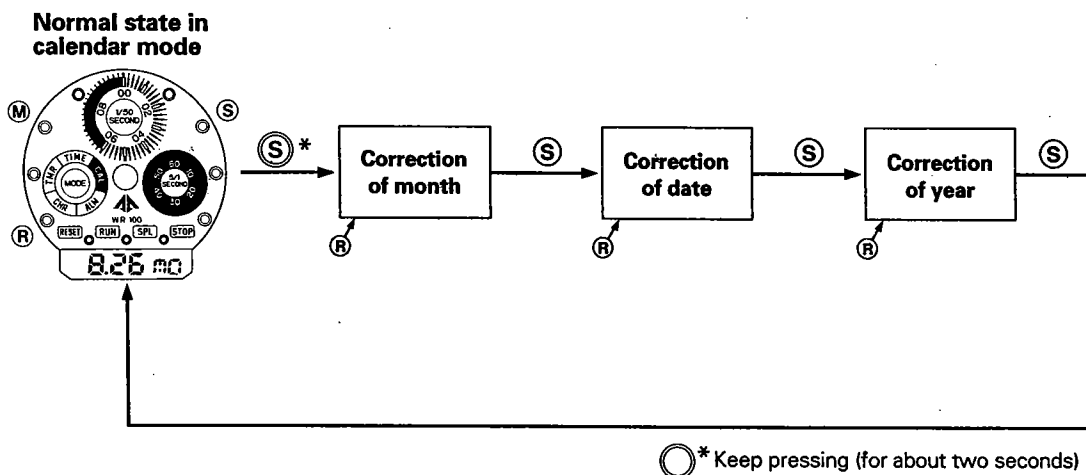

- If a nonexistent date is set, the watch automatically indicates the first of the next month when it is returned to the normal state.

**Example:** Feb. 31 → Mar. 01

- The year can be set to 1991 to 2006, and lower two figures are indicated in the correction state.
- The day of the week is automatically set when the year, month and date are set.
- No correction of the end of the month of calendar is required as far as the years of 1991 through 2006 are concerned.

### c. ALARM MODE (ALM)

#### Setting method of alarm

- The alarm is turned on and off every time the (R) button is pressed in the normal state of the alarm mode.  
(At this time, a confirmation sound comes out.)
- Under the alarm mode, keep pressing the (S) button for about two seconds to set the watch in the state under which alarm can be corrected. Then correct the time of alarm properly with the (R) button. Then, call the item to be corrected by pressing the (S) button, and correct it with the (R) button.
- If the (R) button is kept pressed when the watch is in the correction state, the indicated item is changed quickly.
- The 12/24H systems are in accordance with the time mode.
- The alarm sounds for about 20 seconds. It can be stopped by pressing any button.
- The alarm does not sound in the correction state under any operation mode.

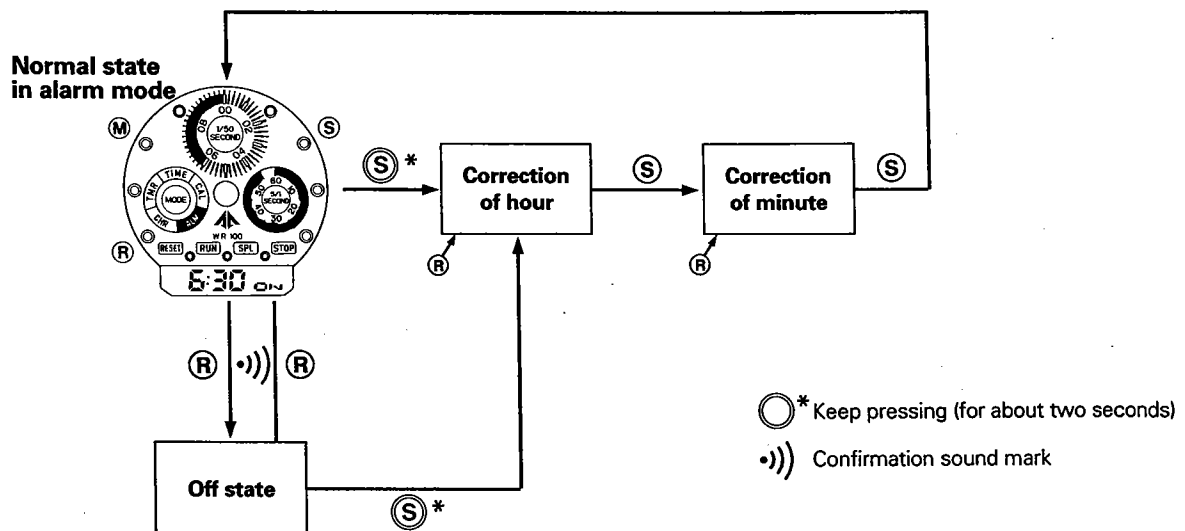

#### • Auto return

If the watch is left untouched for about two minutes in the correction mode, the watch is automatically brought to the normal state.

#### • Manual return

The watch can be returned to the normal state in the alarm mode from any correction state by pressing the (M) button.

#### • Alarm monitor

If the (R) button is pushed and held, the alarm sounds for monitoring.

#### d. CHRONOGRAPH MODE (CHR)

##### Operating method of chronograph

- Under the chronograph mode, the watch is started/stopped by pressing the **(S)** button.  
If pressing the **(R)** button while the chronograph is running, the chronograph is brought to the split operation mode and split time is indicated for about 10 seconds. If pressing the **(R)** button in the split time indication state, the split time is added by the period of time passed after the split operation mode started.

##### <Measuring range>

Zero (0) hour 00 minute 00 second to 23 hours 59 minutes 59 seconds 99/100 seconds.  
After 24 hours 00 minute 00 second have passed, the indication will be reset.

- If the **(R)** button is pressed in the stop state, the chronograph will be reset.
- Under the chronograph mode, the mode can be changed by pressing the **(M)** button in any state.  
While the chronograph is running, it does not stop even if changing the mode.

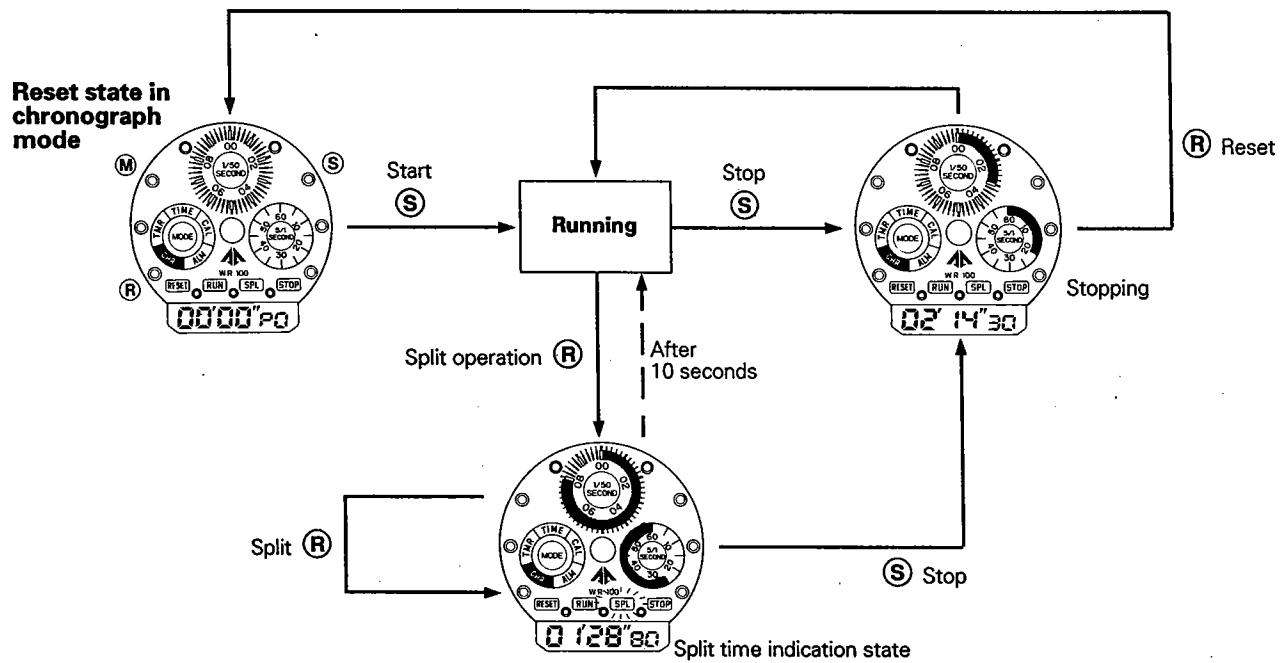

 Flashing mark

**e. TIMER MODE (TMR)**

Graphic indication is given in accordance with the timer indication.

**Handling method of timer**

• **Setting the timer**

In the initial setting state, the timer can be set by pressing the (R) button. If the (R) button is kept pressed, the indicated item can be corrected quickly.  
The timer can be set to 1 minutes through 60 minutes by steps of 1 minute.

• **Start operation**

If the (S) button is pressed in the initial setting state, the timer starts counting down from its initial setting state.

• **Fly-back operation**

If the (R) button is pressed while the timer is running, the timer returns to the initial setting state in the fly-back operation mode and re-starts counting down from the initial setting state.

• **Stop operation**

If the (S) button is pressed while the timer is running, the timer stops running in its stop state. The (S) button is pressed in this state, the timer starts again.

• **Time-up sound**

The alarm sounds for about five seconds each time the timer is up, and the timer returns to the initial setting state.

• **Reset**

If the (R) button is pressed in the stop state, the timer is reset to the initial setting state.

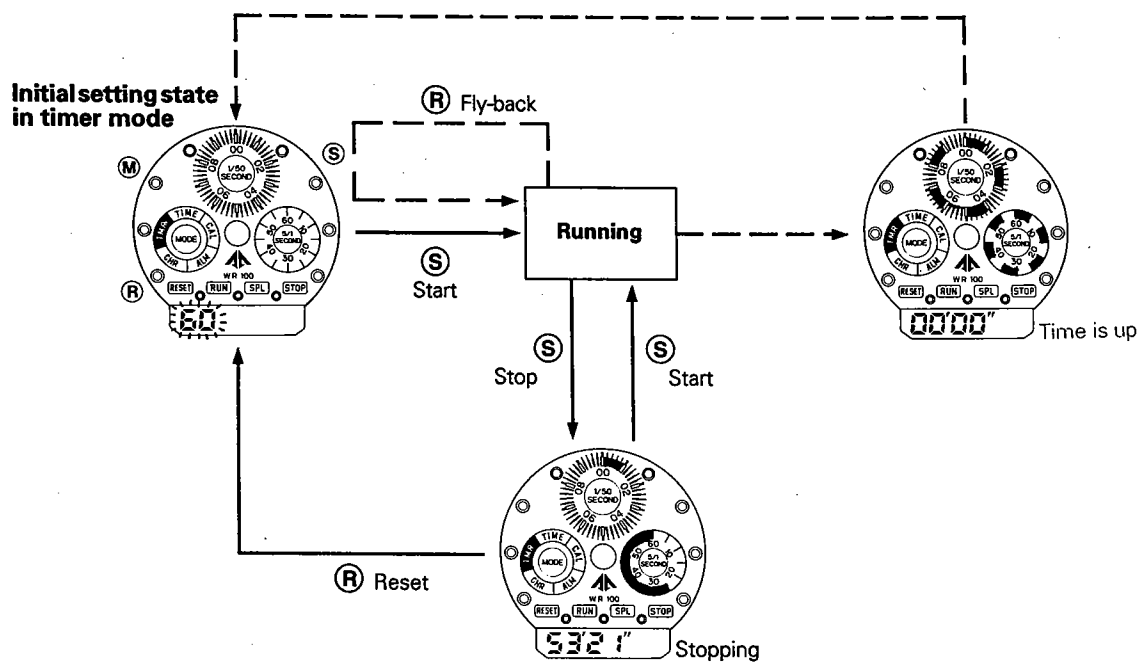

- Under the timer mode, the mode can be changed by pressing the (M) button in any state. While the timer is running, the timer keeps running even if changing the mode.



## §4 HANDLING METHOD OF REGISTER RING

- The register ring can be used in the two different ways during diving, one is to use it as a reference for the time elapsed and the other is to use it as a reference for the time remaining with respect to the preliminary determined period of time.

### <Measuring the time elapsed>

- Set the zero (0) (marked by ▼▼) of the register ring to the minute hand. The scale on the register ring will inform you of the period of time passed after the initial setting.

### <Example>

- 1 Let us suppose that it is 10:10.  
Now, set the zero (0) (marked by ▼▼) of the register ring to the position of minute hand showing 10 minutes past 10.
- 2 After a certain period of time, the time is checked against the watch. It is 10:40.  
The scale of the register ring tells you that 30 minutes have passed after the initial setting. (see Fig. 1)

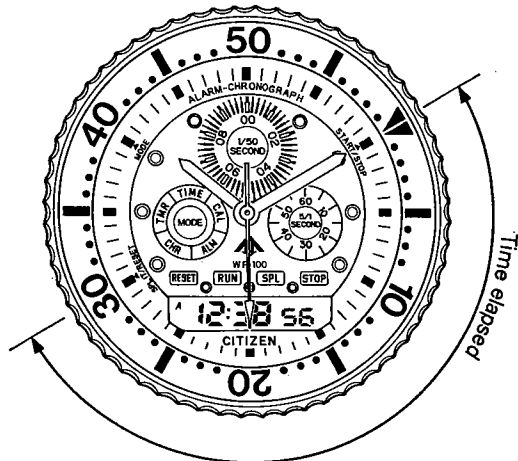

Fig. 1

### <Measuring the remaining period of time>

- If the zero (0) (marked by ▼▼) of the register ring is set to the target time, the remaining period of time with respect to the target time can be measured on the scale of the register ring.

### <Example>

- 1 Let us suppose that the target time is 10:25.  
Set the zero (0) (marked by ▼▼) of the register ring to the position where the minute hand will reach at 10:25.
- 2 Now, it is 10:10. The scale of the register ring tells you that you have 15 minutes to go until the target time of 10:25 is reached. (See Fig. 2.)

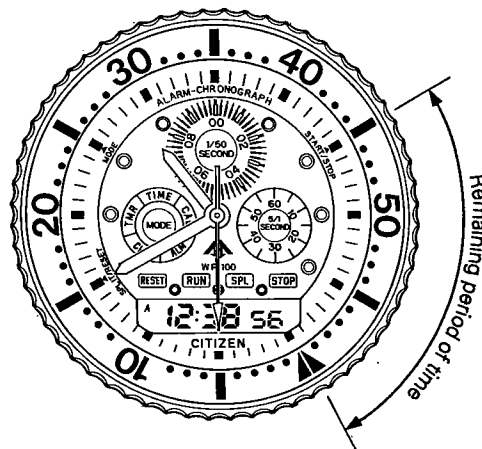
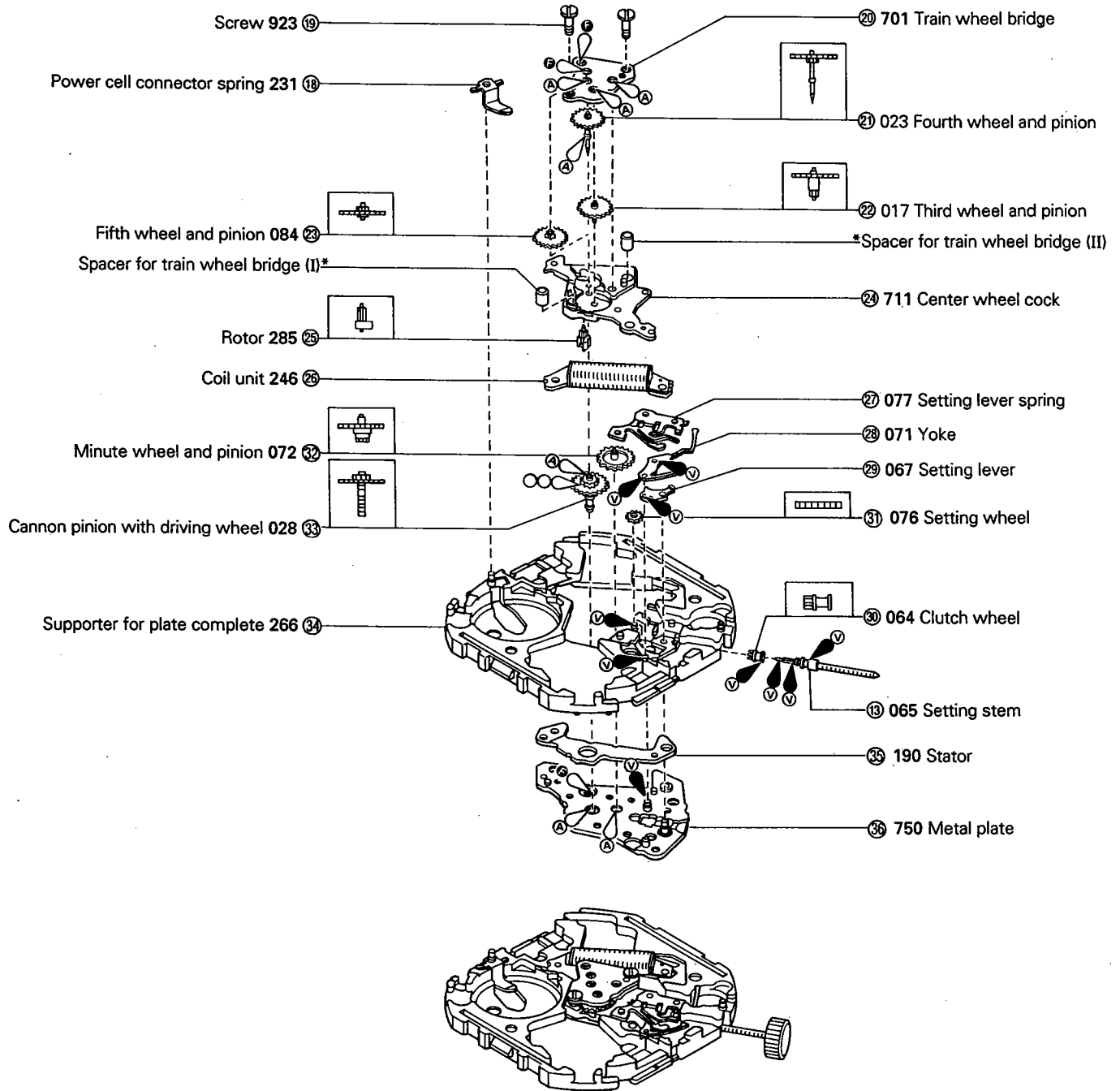
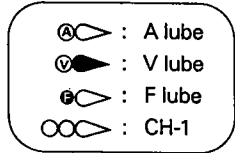

Fig. 2

• Lubrication marks



\* Spacers (I) and (II) for train wheel Bridge are the set parts of the center wheel cock.

## 5 DISASSEMBLE AND ASSEMBLE OF MODULE (Same as CAL C050)

Disassemble the parts in order of ① → ③⑥  
Assemble the parts in order of ③⑥ → ①

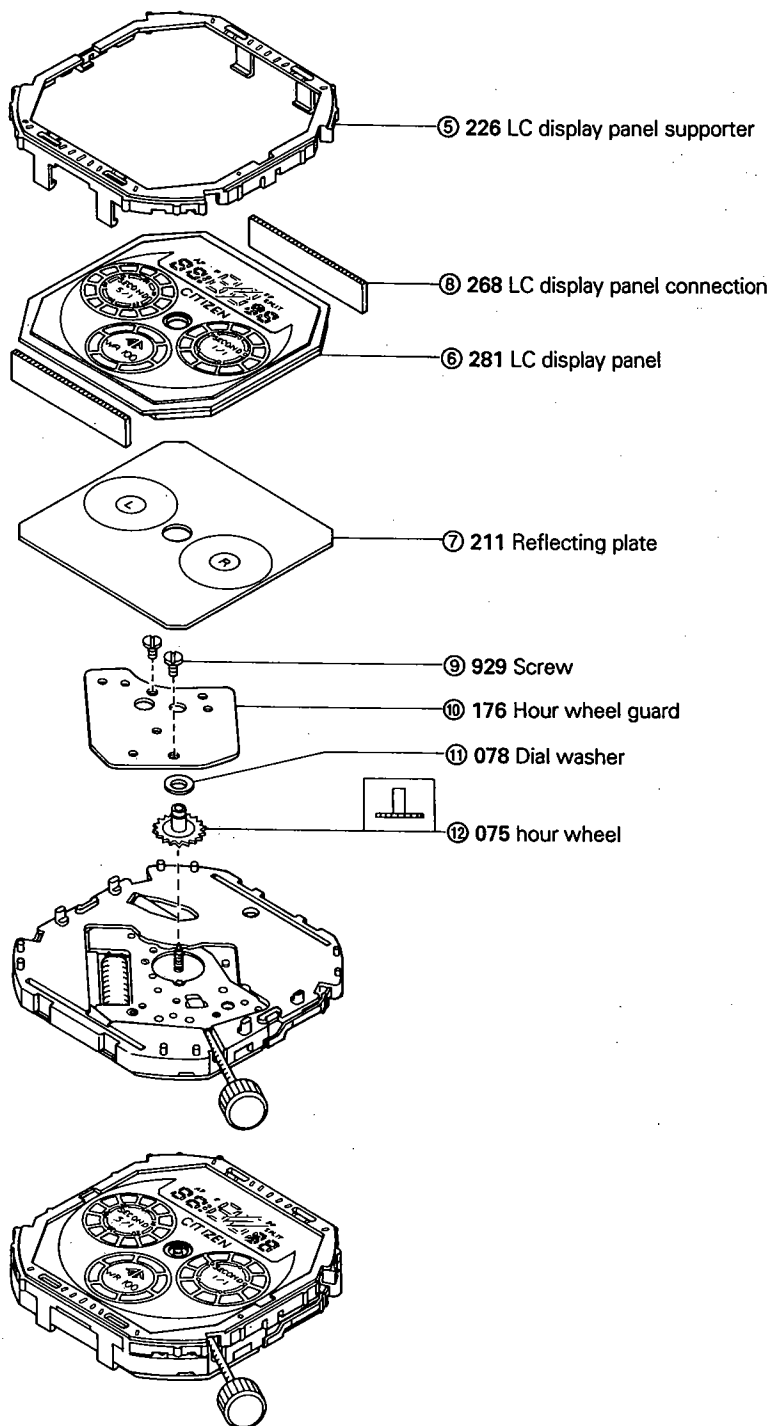

# 6 INSPECTION AND ADJUSTMENT METHOD OF MODULE

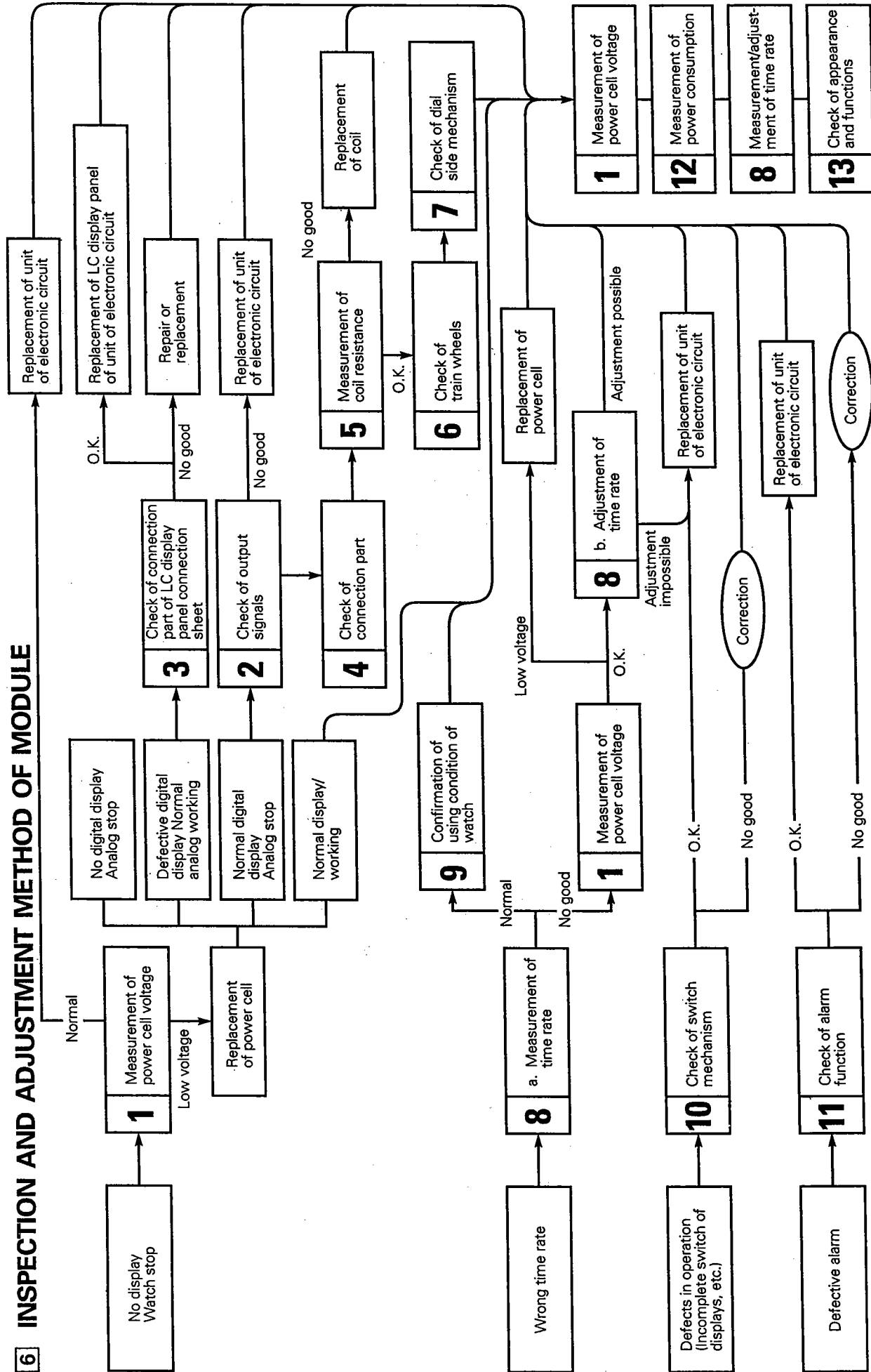

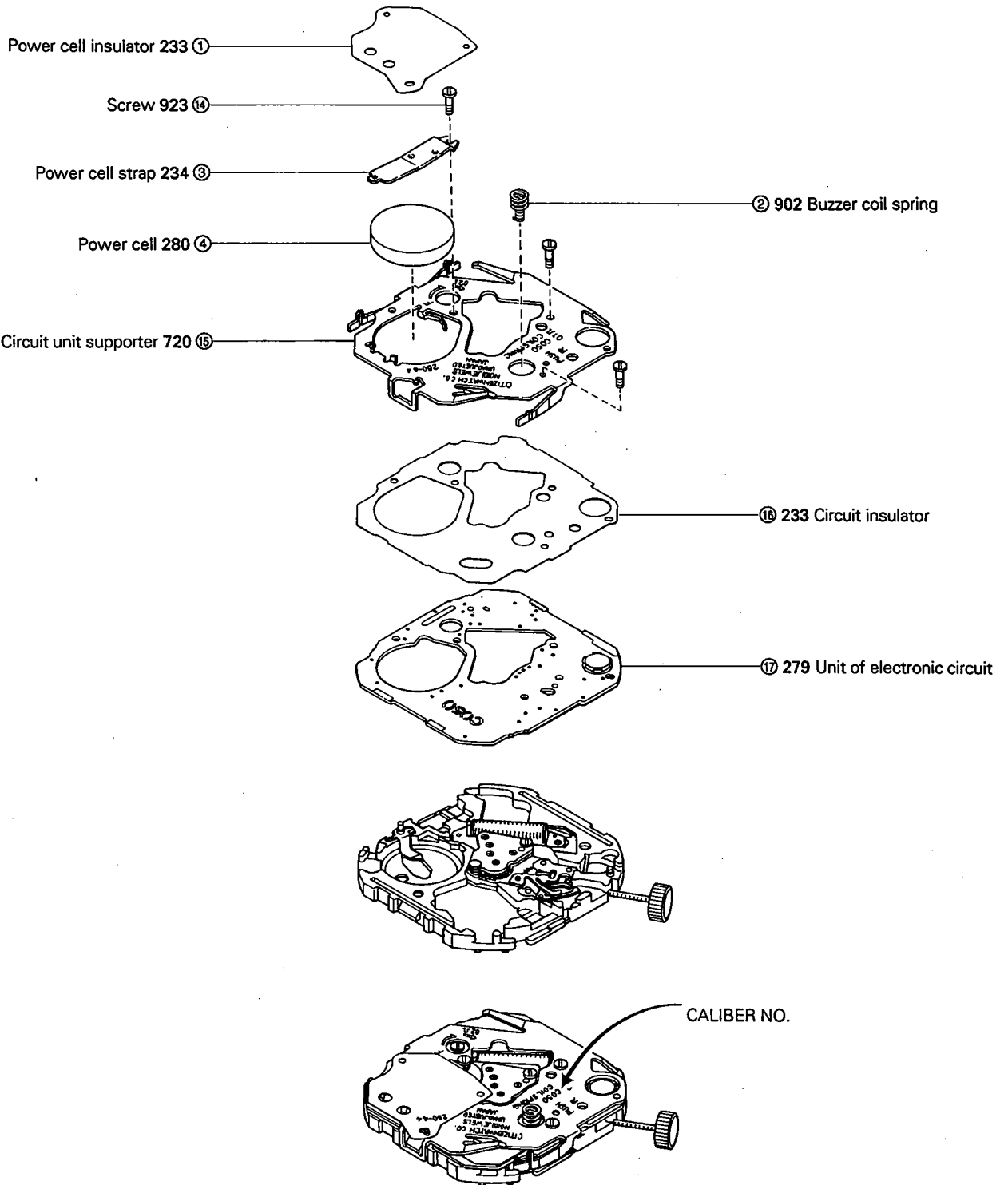

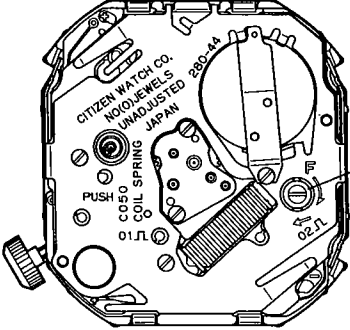
Check points	How to check	Results & treatment
<p>⑤ Measurement of coil resistance</p>	<p>[Refer to Technical Manual Basic Course II-1-c]</p> <ul style="list-style-type: none"> <li>Remove the unit of electronic circuit, then measure the resistance of coil.</li> <li>The tester lead pins have no polarity.</li> </ul> <p style="text-align: right;">&lt;Tester range: R x 10Ω&gt;</p>	<ul style="list-style-type: none"> <li>2.2 kΩ ~ 2.6 kΩ → Normal</li> <li>Outside range of 2.2 kΩ ~ 2.6 kΩ → Replace coil unit.</li> </ul>
<p>⑥ Check of train wheels</p>	<p>[Refer to Technical Manual Basic Course II-2-b]</p> <ul style="list-style-type: none"> <li>Check clearance of each wheel. Check rotor for bust and oil.</li> </ul>	
<p>⑦ Check of dial-side mechanism</p>	<p>[Refer to Technical Manual Basic Course II-2-c]</p> <ul style="list-style-type: none"> <li>Confirm all parts are not deformed and are lubricated properly.</li> </ul>	
<p>⑧ Measurement and adjustment of time rate</p>	<p>[Refer to Technical Manual Basic Course II-2-d]</p> <p>Measurement range: Analog, 2 sec.</p>  <p style="text-align: right;">Trimmer capacitor</p> <ul style="list-style-type: none"> <li>Turn trimmer capacitor to right and left to adjust time rate.</li> </ul>	<ul style="list-style-type: none"> <li>Can be adjusted. → Normal</li> <li>Cannot be adjusted or large error is made after adjustment. → Replace the electronic circuit unit.</li> </ul>
<p>⑨ Confirmation of using condition</p>	<p>[Refer to Technical Manual Basic Course II-2-e]</p>	

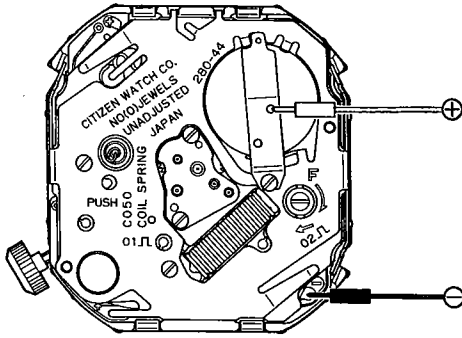
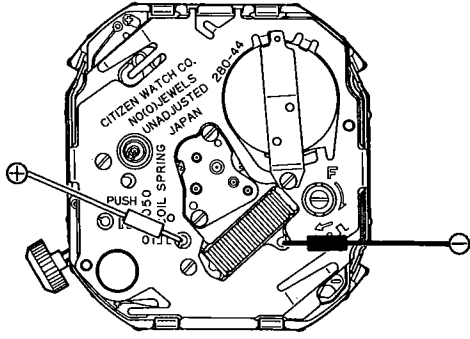
Check points	How to check	Results & treatment
<p>① Measurement of power cell voltage</p>	<p>[Refer to Technical Manual Basic Course II-1-a]</p> <p>&lt;Tester range: DC 12V&gt;</p> 	<ul style="list-style-type: none"> <li>• <b>Over 1.5V</b> → Normal</li> <li>• <b>Under 1.5V</b> → Replace the power cell.</li> </ul>
<p>② Check of output signals</p>	<p>[Refer to Technical Manual Basic Course II-1-b]</p> <p>&lt;Tester range: DC 0.3V&gt;</p>  <p>(The tester lead pins have no polarity.)</p>	<ul style="list-style-type: none"> <li>• The tester pointer swings every 1 second. → Normal</li> <li>• The tester pointer does not swing. → Check the connections parts</li> </ul> <p style="text-align: center;">↓</p> <ul style="list-style-type: none"> <li>• The connections are normal. → Replace the electronic circuit unit.</li> </ul>
<p>③ Check of LC display panel and connection part</p>	<p>[Refer to the Digital Section of Technical Manual Basic Course II-2-a]</p> <ul style="list-style-type: none"> <li>• Inspection of all segments Pull out the crown and push the (M), (S) and (R) buttons at the same time to turn on all the segments, and check for defective ones. (Refer to [4] PRECAUTIONS FOR REPLACING THE POWER CELL (page 24))</li> <li>• Continuity test on LC display panel, cell connection rubber and plate complete. Check the parts for stain, breakage, etc.</li> </ul>	<ul style="list-style-type: none"> <li>• LC display panel, connection rubber or metal plate is not installed correctly. → Install correctly</li> <li>• Parts are stained or dirty. → Remove stain and dirt.</li> <li>• Parts are cut, broken or scratched. → Replace parts.</li> </ul>
<p>④ Check of connection part</p>	<p>[Refer to Analog Section of Technical Manual Basic Course II-2-a]</p>	

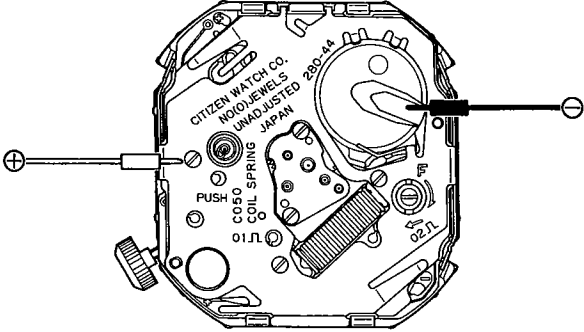
Check points	How to check	Results & treatment
<p>⑫ Measurement of current value (Power consumption)</p>	<p>[Refer to Technical Manual Basic Course II-1-f]</p> <p>(1) Set the power cell to tester.  (2) Set the lead bars of the tester to the module. Pull the crown and push the (M), (S), and (R) button at the same time, then push the crown (The all-reset operation procedure). Then, measure the current consumption &lt;Use the tester range of DC 12μA&gt;.</p> 	<ul style="list-style-type: none"> <li>Measured value of module complete is <b>under 3.1 μA</b>. → Normal</li> <li>Measured value of module complete is <b>over 3.1 μA</b>. → Inspect train wheel and dial side mechanism, and remove dust and stain, and oil.</li> <li>Pull the crown to measure the power consumption under the reset state. → Normal</li> </ul> <p><b>Under 2.5μA.</b> → Electronic circuit unit is defective.</p> <p style="text-align: center;">↓</p> <p>Replace the electronic circuit unit.</p>
<p>⑬ Check of appearance and functions</p>	<p>[Refer to Technical Manual Basic Course II-2-f]</p> <ul style="list-style-type: none"> <li>Check inside of case for dust and stain.</li> <li>Check operation of setting switches for normality.</li> <li>Check segment for normality (See ④ Check LC display panel and connection part.)</li> </ul>	



Check points	How to check	Results & treatment
<p>⑩ Check of switch mechanism</p>	<p>1. Inspection of movement.</p> <ul style="list-style-type: none"> <li>• Press the switch spring of circuit unit supporter with tweezers, etc. to contact it to plate complete, and confirm the switching function.</li> <li>• Check for removal of pattern of electronic circuit unit, deformation of switch return spring, etc.</li> </ul> <p>2. Inspection of push button</p> <ul style="list-style-type: none"> <li>• Check push button for deformation, stain, etc.</li> </ul> <div data-bbox="467 491 1081 646" style="border: 1px solid black; padding: 5px; margin-top: 10px;"> <p>(Note) Be sure to apply silicone oil to the packing of push button for waterproofness and smooth operation. Apply it to the packing of the sensor, too.</p> </div>	<ul style="list-style-type: none"> <li>• Switching function is normal. → Inspect push button.</li> <li>• Pattern is removed or deformed. → Replace defective parts.</li> <li>• Push button is stained or deformed. → Remove stain, or replace push button.</li> </ul>
<p>⑪ Check of alarm mechanism</p>	<p>[Refer to Technical Manual Basic Course II-1-d]</p> <p>*1. Set the module in the case, and check output of alarm with the case back removed.</p> <ol style="list-style-type: none"> <li>(1) Set the watch in alarm mode.</li> <li>(2) Apply ⊕ lead pin to power cell surface and ⊖ lead pin to buzzer contact spring, then press Ⓜ button.</li> </ol> <p style="text-align: right;">&lt;Tester range: DC 0.3V&gt;</p> <div data-bbox="521 1262 1068 1591" style="text-align: center;"> </div> <p>*2. If the output of alarm is normal, perform the following inspection.</p> <ul style="list-style-type: none"> <li>• Check the piezo-electric element of vibrating plate for cracks and breakage.</li> <li>• Check the buzzer contact spring for bend and deformation.</li> <li>• Check the pattern of electronic circuit unit for dust and stain.</li> </ul>	<ul style="list-style-type: none"> <li>• Tester pointer does not swing. → Replace the electronic circuit unit.</li> </ul> <p style="text-align: center;">↓</p> <ul style="list-style-type: none"> <li>• Tester pointer swings. → Normal</li> </ul> <p style="text-align: center;">↓</p> <ul style="list-style-type: none"> <li>• Perform inspection in *2.</li> </ul> <p style="text-align: center;">↓</p> <p>Normal indication. → O.K</p>



**CITIZEN WATCH CO., LTD.**  
Tokyo, Japan